

Slicktri Ultra Slim 18W LED Tri-CCT Downlight Kit - 205mm Round

Brand: CLA LIGHTING • Product SKU: CLA-SLICKTRI3R-1419 • RRP: \$82.25



PRODUCT DESCRIPTION

The Slicktri round framed LED downlight is a standard recessed light designed for any modern home. It has an ultra-slim profile of 22mm that is perfect in narrow ceiling applications. A cost-effective light fitting that suits standard Australian dimmers, and can be switched to 3 colours for flexibility of use.

FEATURES

- **ULTRA SLIM** - Compact 22mm height is made to recess into ceilings with very narrow spaces
- **EFFICIENT** - Requires less current while still producing high luminosity (equivalent to a standard 145W incandescent globe)
- **TRI COLOUR** - Light colour is changeable (3000K, 4000K, 5000K) via inline switch so you can use it in any room
- **DIMMABLE** - Designed to work with Australian dimmers such as Diginet, Clipsal, and HPM (Recommended to be used with LED-specific dimmers)
- **DIY READY** - If you have existing installed in-ceiling sockets and a compliant environment, simply plug in!

Information and prices shown in this document may change without prior notice. Please refer to our website for the most accurate, up-to-date information about this product.



Money Back Guarantee*



Enjoy Free Freight Protection



Earn Reno Dollars as a MEMBER

ADDITIONAL INFORMATION

Specifications

- **Cut Out Size:** Ø205mm
- **Fixture Dimensions:** Ø222mm x 22mm (Ultra slim)
- **Driver Dimensions:** 87mm x 37mm x 20mm
- *The driver should NOT BE covered with thermal insulation*
- **Inline Switch Dimensions:** 45mm x 23mm x 15mm
- **Mounting:** Recessed
- **Frame Style:** White round
- **Housing and Face Plate Material:** PC
- **Diffuser:** White PS
- **Flex & Plug:** Included, 1.2m
- **Input Voltage:** 220-240V 50Hz
- *Remote constant current driver included*
- **Wattage:** 18W
- **LED Chips:** SMD2835 (60pcs 3000K + 60pcs 5000K)
- **Power Factor:** 0.9
- **CRI:** ≥80
- **CCT and Lumens:** Changeable 3000K (1350lm) / 4000K (1550lm) / 5000K (1450lm)
- *Changeable colours by switch on DC cable*
- **Beam Angle:** 110°
- **Dimmable?:** Yes
- *Please check with licensed electrician for min. and max. dimmer load*
- *For best performance and compatibility, we recommend using LED-specific dimmers*
- **Suitable for 2-way Switching?:** Yes
- **Suitable With Microwave & Motion Sensor?:** Yes
- **Double Insulated?:** Yes
- **IC Rating:** IC-4
- **Ambient Temperature:** -20 to 40°C
- **IP Rating:** IP40
- **Lifetime:** 30,000 hours regular home use

Information and prices shown in this document may change without prior notice. Please refer to our website for the most accurate, up-to-date information about this product.



Money Back Guarantee*



Enjoy Free Freight Protection



Earn Reno Dollars as a MEMBER

ADDITIONAL INFORMATION

Dimensions

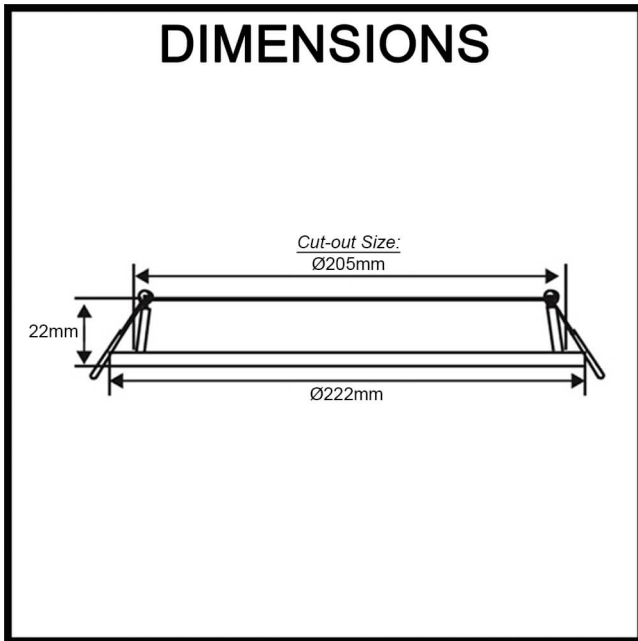

Information and prices shown in this document may change without prior notice. Please refer to our website for the most accurate, up-to-date information about this product.



Money Back Guarantee*



Enjoy Free Freight Protection



Earn Reno Dollars as a MEMBER